

5

4

3

2

1

D



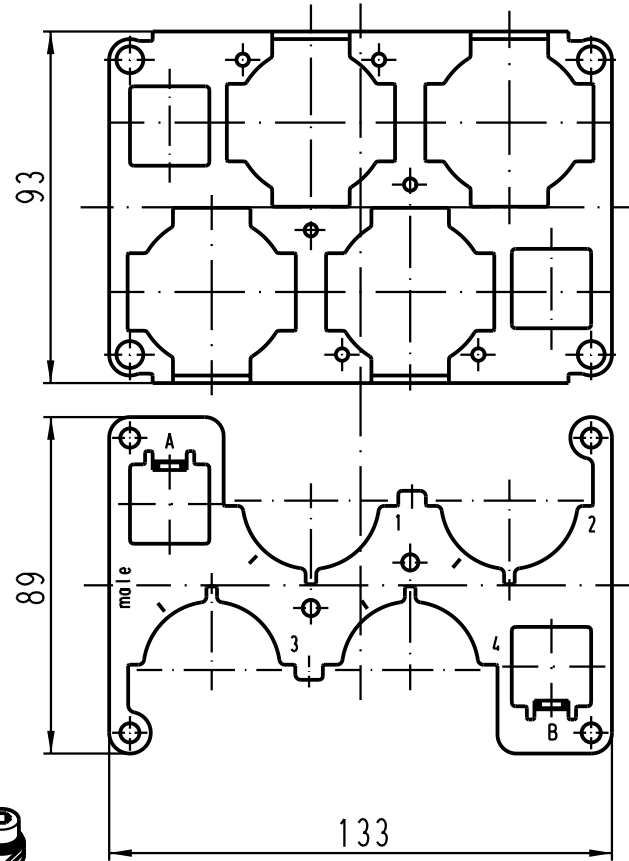

C

B

A



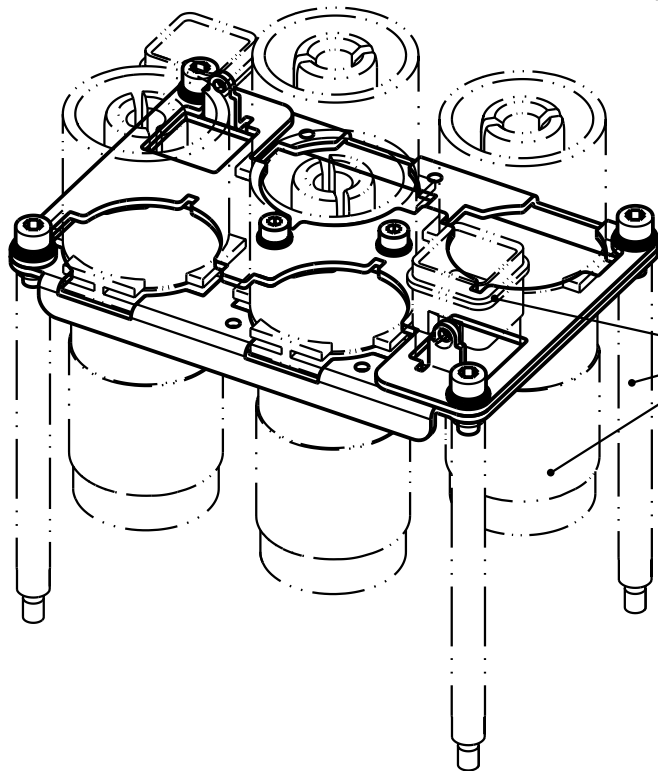

Lose mitgeliefert:/  
separately enclosed:

-  4 x Zylinderschraube M5x12/  
4 x fillister head cap screw M5x12
-  4 x Sperrkantscheibe SK S5/  
4 x washer M5
-  2 x Zylinderschraube M4x10/  
2 x fillister head cap screw M4x10
-  2 x Sperrkantscheibe SK S4/  
2 x washer M4

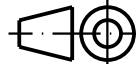

nicht im Lieferumfang enthalten/  
not range of delivery

 All Dimensions in mm Original Size DIN A 4		Techn. Character.			Nicht tolerierte Masse/ Free size tolerances	
			Dat.	Name	Massstab/Scale  1:2	Halterung Han 4HC Stift 4 x 650A Frame Han 4HC male 4 x 650A Han 48HPR
		Detail.	27.03.03	Ho		
		Insp.		Ole		
		Stand.				
410968	20.04.04	Loe.	HARTING Electric GmbH & Co. KG			TB 09 40 048 9811
410435			D-32339 Espelkamp			
Mod.	Dat.	Name				
					Sub.	Blatt/ page