

1 2 3 4 5 6

A

B

C

D

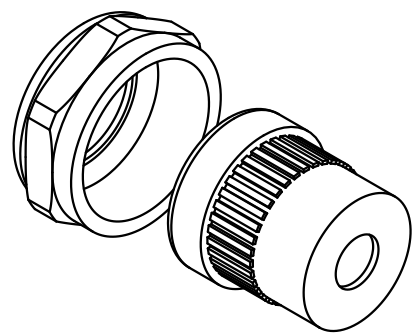
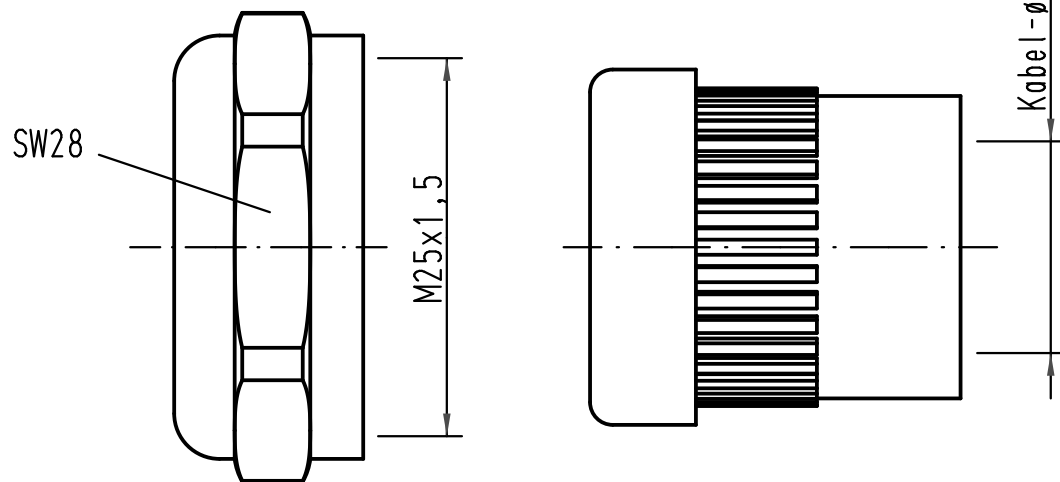

Für Tüllen- und Kupplungsgehäuse - Metall
for hoods and cable to cable hoods - metal

All Dimensions in mm Original Size DIN A 4		Techn. Character.			Nicht tolerierte Maße/Free size tolerances	
			Dat.	Name	Maßstab/Scale 2:1	Han-Compact Halbverschraubung M25 <i>half cable protection M25</i>
			Detail.	08.02.10 Ho		
			Insp.	Sch		
			Stand.			
A			HARTING Electric GmbH & Co. KG			TB 19 12 000 5057
Mod.	Dat.	Name	D-32339 Espelkamp			
					Sub. TB 19 12 000 5057 v. 09.11.01	
					Blatt/page	