

1 2 3 4 5 6

A
B
C
D

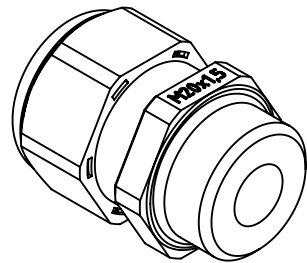
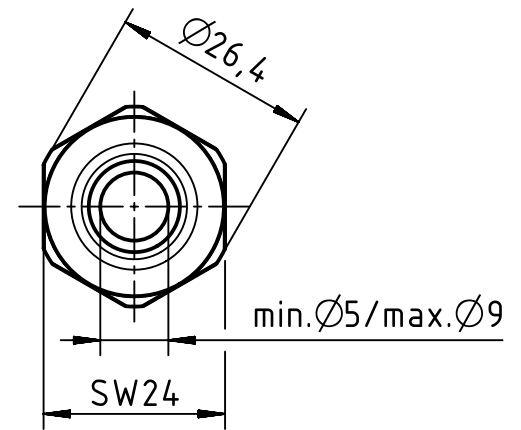
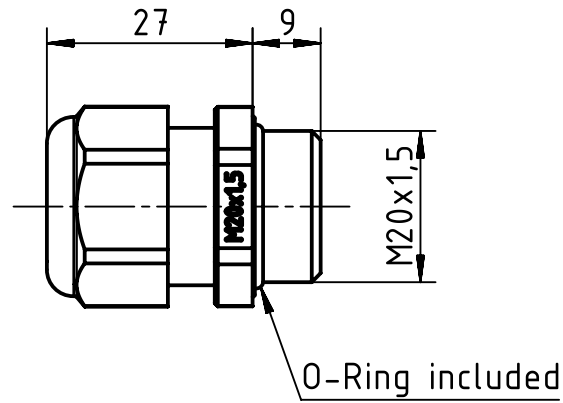

	All Dimensions in mm Original Size DIN A4		Scale 1:1	Free size tol.		Ref.
						Sub.
	All rights reserved		Created by LONGL	Inspected by DINGB	Standardisation TIEMANNA	Date 2016-03-04
	Department EL PD - DE					State Final Release
HARTING Electric GmbH & Co. KG D-32339 Espelkamp			Title Han CGM-P M20x1,5 D.5-9mm grey			Doc-Key / ECM-Nr. 100191505/UGD/005/B 500000100783
			Type TB	Number 19 00 000 5180		Rev. B Page 1/1