

Alle Rechte vorbehalten/ All rights reserved

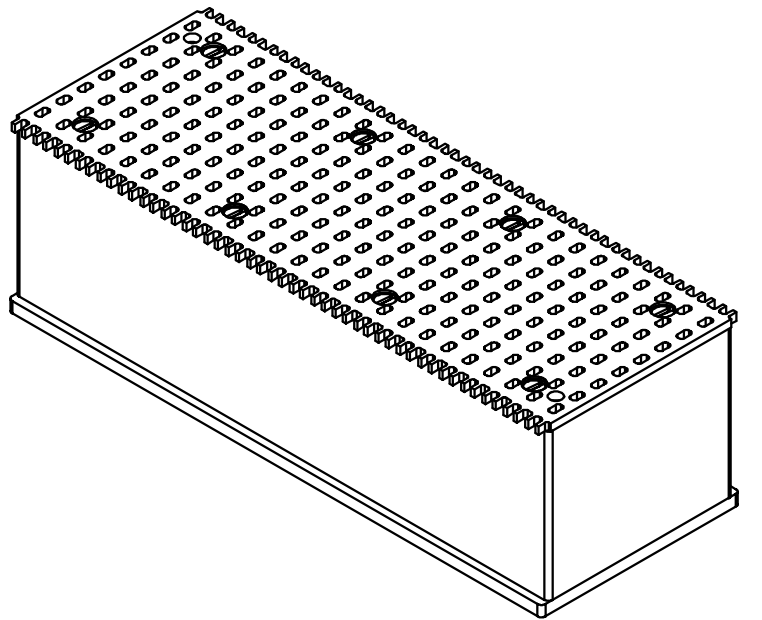
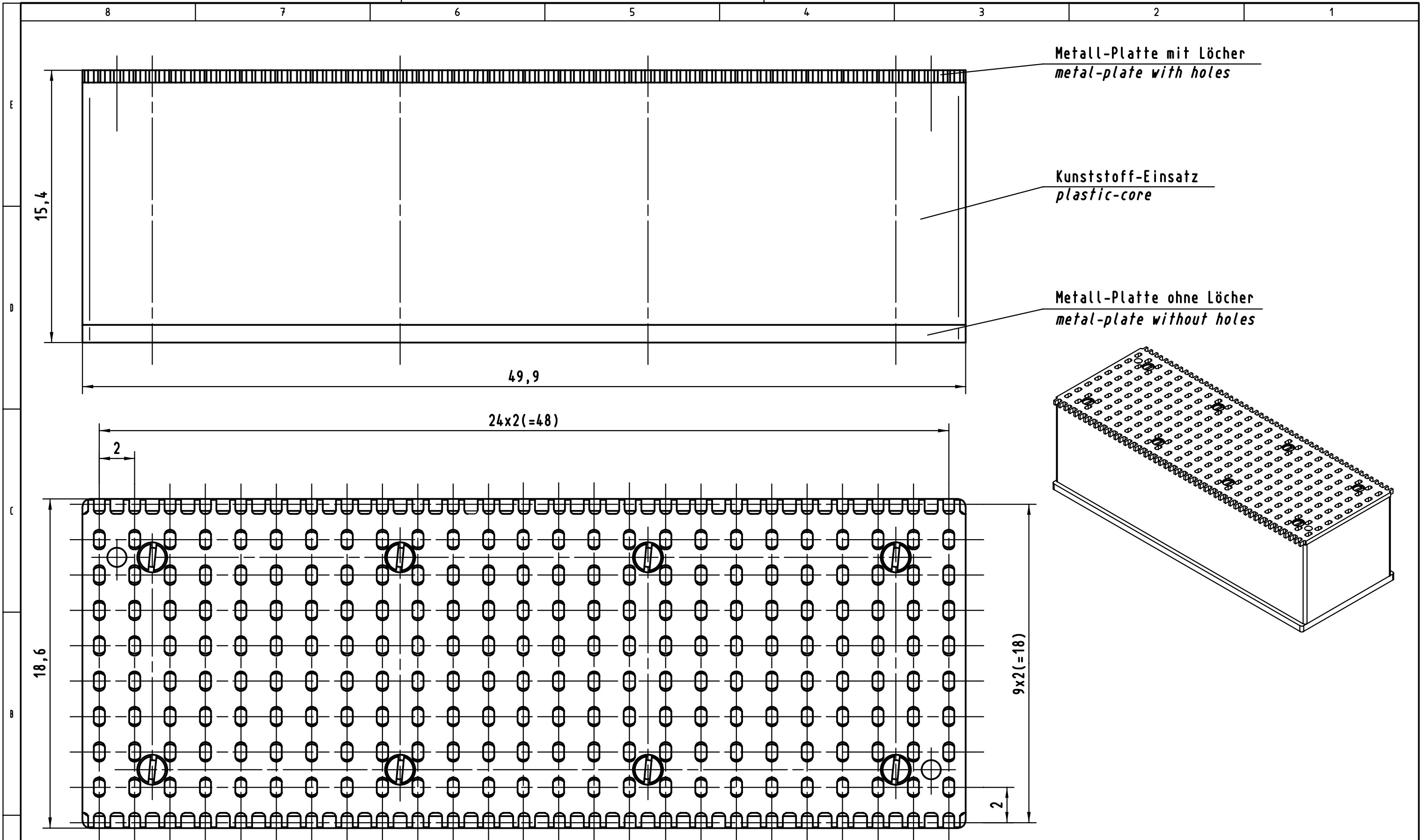

All Dimensions in mm Original Size DIN A 3		Techn. Character.			Nicht tolerierte Maße/ Free size tolerances	
			Dat.	Name	Maßstab/Scale 5:1	Einlegeteil / Insert har-bus HM 50 (8+2)
			Detail.	11.09.98 Hage		
			Insp.	11.09.98 Wae		
			Stand.			
24585			HARTING KGaA			TB 17 99 000 0007
1Druckblech	21.07.99	Hage	D-32339 ESPELKAMP			
Mod.	Dat.	Name				Blatt/ page
						Sub.