

1 2 3 4 5 6

A

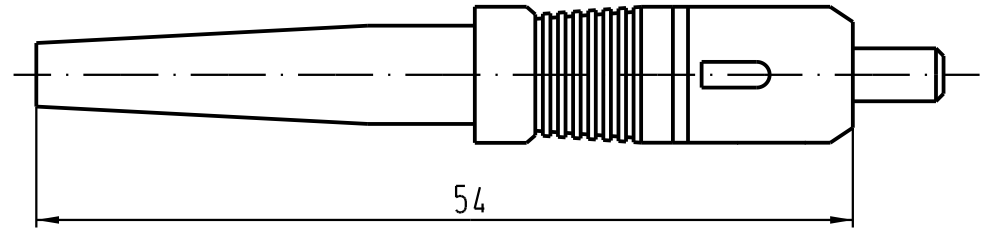

B

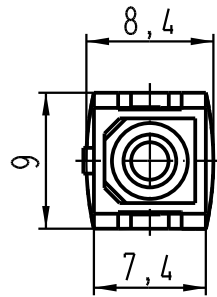
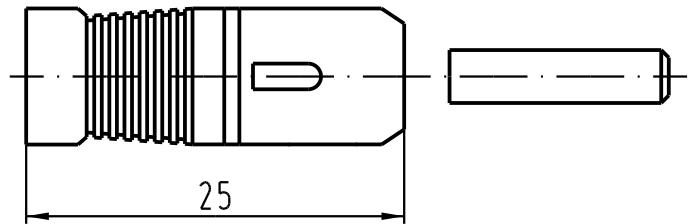
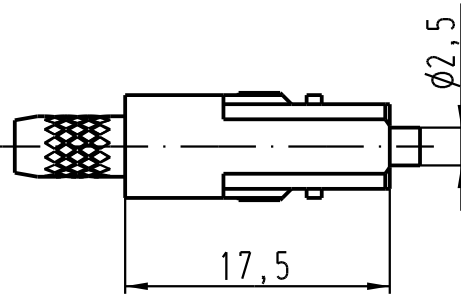
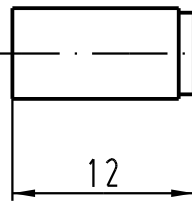
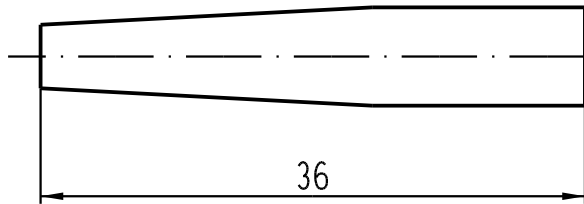

C

Crimphülse und Knickschutz für LWL-Kabel  $\phi 2,4-2,8\text{mm}$   
 Crimping sleeve and bood for cable diameter  $\phi 2,4-2,8\text{mm}$

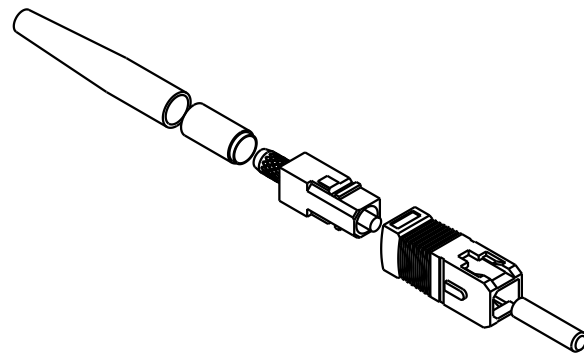

D

All Dimensions in mm Original Size DIN A 4		Techn. Character.			Nicht tolerierte Masse/ Free size tolerances	
			Dat.	Name	Massstab/ Scale  2:1	LWL-Stecker SC Simplex fo-connector SC Simplex for optical fibre 200/230 $\mu\text{m}$
		Detail.	24.11.05	Ho		
		Insp.		Be		
		Stand.				
411896		HARTING Electric GmbH & Co. KG D-32339 Espelkamp				TB 20 10 230 5211
Mod.	Dat.	Name				