

X (2:1)

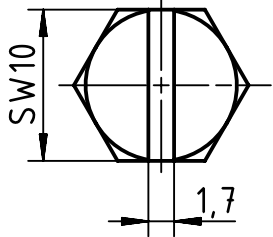

Seal

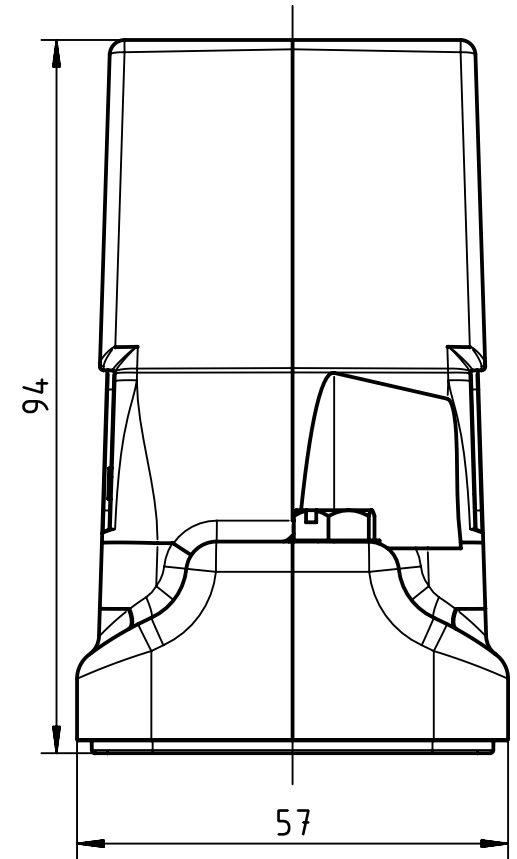
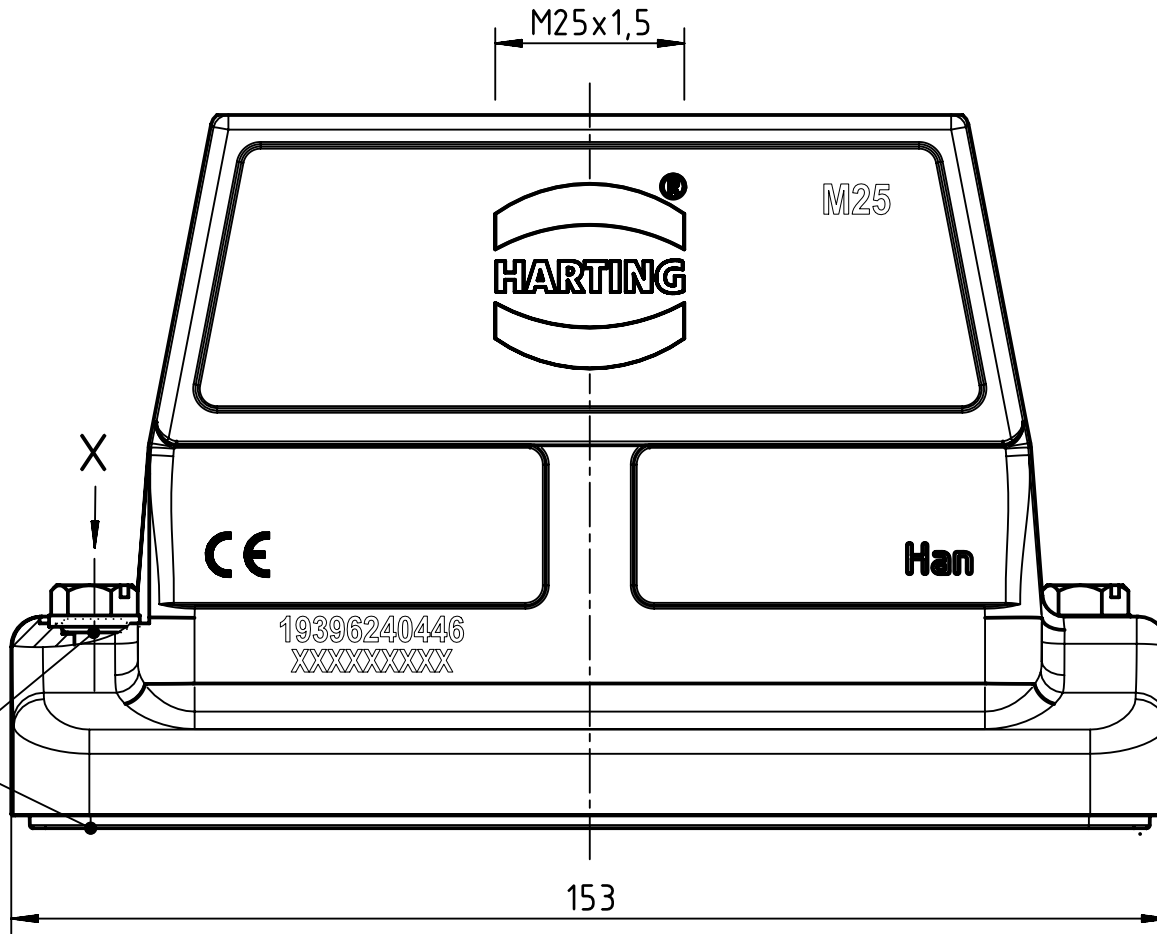

Panel cut out (1:2)

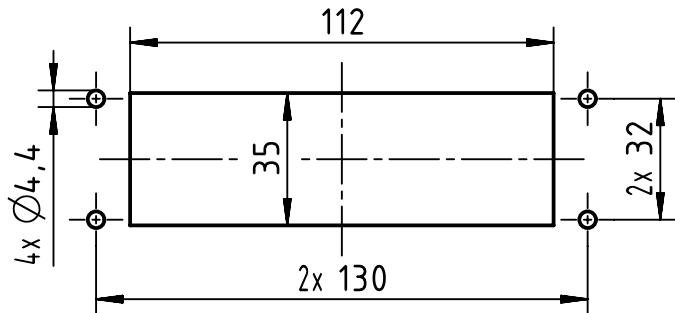

	All Dimensions in mm Original Size DIN A4		Scale 1:1	Free size tol.		Ref.	
	All rights reserved		Created by ZHUANGJ	Inspected by LUOK	Standardisation ROEBEN	Sub.	
Department EL PD		Title Han 24HP Direct/B-HTE-M25		Date 2021-11-23	State Final Release		
HARTING (Zhuhai) Manufacturing Co., Ltd. 519085 Zhuhai, China		Type TB	Number 19 39 624 0446		Doc-Key / ECM-Nr. 100632601/UGD/003/G 500000206678	Rev. G	Page 1/1